



LCS - Lincat Lynx 400 Electric Counter-top Chip Scuttle - W 285 mm - 0.25 kW

Ensure your chips and other fried food are kept at the optimum temperature with the Lynx 400 Chip Scuttle.

- ✔ Provide a continuous supply of chips and other fried food, quickly and easily
- ✔ The perforated drain plates ensures any excess oil is drained away, helping to keep chips crisp
- ✔ Adjustable temperature control
- ✔ Easy to clean removable drain plates and interior
- ✔ No installation required, just plug in.

Specifications

Summary

Brand	Lincat
Range	Lynx 400
Power Type	Electric
Unit Type	Counter-top
Available in UK Only	No
UK Warranty	2 Years Parts and Labour Warranty
Export Warranty	Contact your local dealer
GTIN	5056105101055

Power and Performance

Total Power kW	0.25
IP Rating	IP23
Temperature Control	Mechanical

Key Specifications

Heated Base	Yes
Heated Gantry	No

Weights and Dimensions

Unit Height (External) mm	232
Unit Width (External) mm	285
Unit Depth (External) mm	400
Net Weight Kg	6.7

Supply Connections

Requires Installation	No
Requires Electrical Supply	Yes
UK 3 Pin Plug	Yes
Requires Hardwiring	No
Electrical Supply Rating Watts	250
Single Phase Amps	1.1
Single Phase Voltage	230

Shipping

Packed Weight Kg	8.5
Packed Height cm	42
Packed Width cm	48
Packed Depth cm	38

Technical Picture

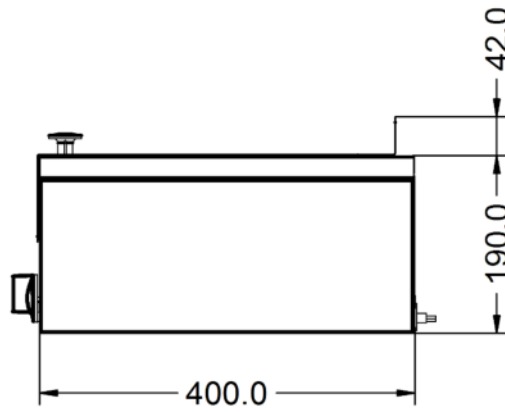
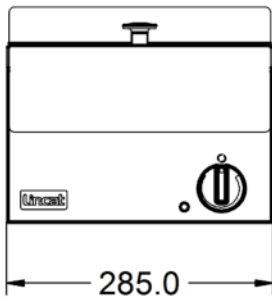
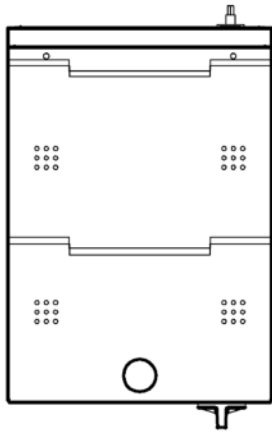

Lincat Limited

Whisby Road,
Lincoln, LN6 3QZ,
United Kingdom

Company No: 2175448

A member company of



Customer Care

Tel: +44 1522 875500
Email: care@lincat.co.uk

Export Customers

Tel: +44 1522 875536
Email: export@lincat.co.uk

Opening Hours

Monday – Friday:
8.30am – 5pm