



F58/903 - IMC SP12H Floor-mounted Potato Peeler - 3 Phase - H 1400 mm - 0.37 kW

Compact and flexible, the SP12(3PH) peeler has a high output and small footprint, making it ideal for medium and large operations with three-phase power.

- ✓ Able to peel 12kg of potatoes in 2 minutes - up to 220kg per hour
- ✓ Upright design with small footprint, ideal for medium and large operations
- ✓ High pedestal makes unit the perfect height to empty into a sink
- ✓ Lubricated, heavy-duty gearbox makes peeling operation smooth and reliable
- ✓ Dual position waste outlets and smooth cylinder base for quick, easy cleaning
- ✓ Long-lasting, rust-proof plate and replaceable liners for effective peeling
- ✓ Suitable for kitchens with three-phase power supply
- ✓ WRAS-approved Class A air-break and brass spray nozzle to prevent water escape

Specifications

Summary

Brand	IMC
Range	SP Peeler
Power Type	Electric
Unit Type	Floor-mounted
Available in UK Only	No
UK Warranty	2 Years Parts and Labour Warranty
Export Warranty	Contact your local dealer
Mounting	Floor-mounted
GTIN	5056105198802

Power and Performance

Total Power kW	0.37
HP	0.5
IP Rating	IP55

Key Specifications

Operator Safety	User Guide
Timer	Yes
Drain Location	Right or left
WRAS Approved	WRAS Compliant
Airbreak	Yes

Capacity

Capacity Kg per Hour	220
-----------------------------	-----

Weights and Dimensions

Unit Height (External) mm	1388
Unit Width (External) mm	530
Unit Depth (External) mm	624
Net Weight Kg	50.5

Supply Connections

Requires Installation	Yes
Requires Electrical Supply	Yes
UK 3 Pin Plug	No
Requires Hardwiring	Yes
Motor Rating Watts	370
Three Phase Amps	1.1
Three Phase Voltage	400
Water Connection Pressure Bar	2.7-3.8 [40-55 psi]
Drain Connection	54mm
Water Connection	12mm

Shipping

Packed Weight Kg	55.55
Packed Height cm	148
Packed Width cm	68
Packed Depth cm	57

Available Accessories

- A29/003** Lid Retaining Strap for SP/VQ Potato Peeler
- S58/568** Filter Basket - Integral - for SP Potato Peeler
- S58/569** Interceptor Tank - for SP Potato Peeler [pedestal mounted/2" BSP]
- S58/570** Waste Ejector for SP Potato Peeler [2" BSP]

Technical Picture

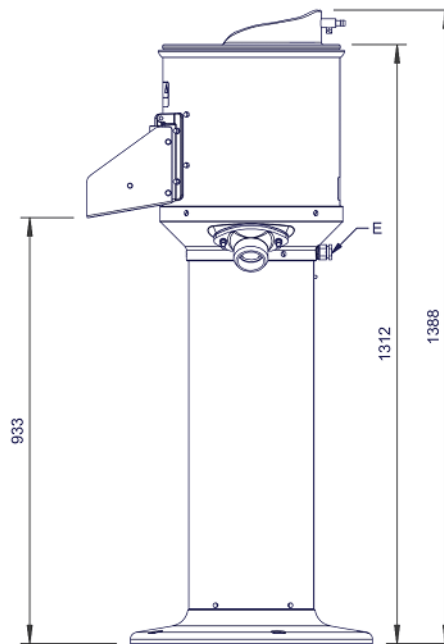
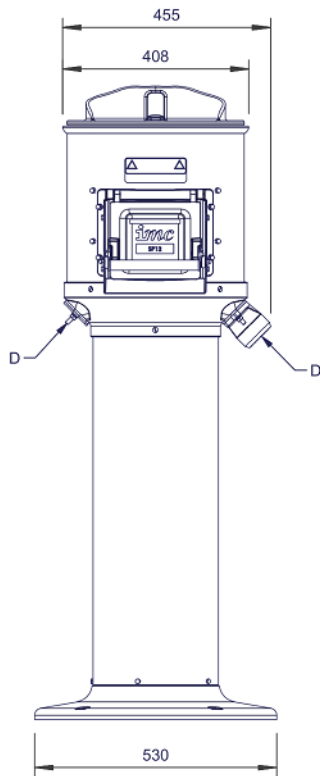
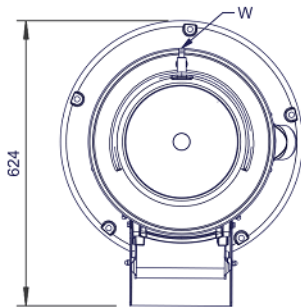



Lincat Limited

Whisby Road,
Lincoln, LN6 3QZ,
United Kingdom

Company No: 2175448

A member company of



Customer Care

Tel: +44 1522 875500
Email: care@lincat.co.uk

Export Customers

Tel: +44 1522 875536
Email: export@lincat.co.uk

Opening Hours

Monday – Friday:
8.30am – 5pm